

GB Operating manual

High-pressure cleaner

K 1152 TS

K 1152 TST



Operating manual

GB

High-pressure cleaner

K 1152 TS

K 1152 TST

Operating manual!

Read and conform safety instructions before use! Keep instructions in a safe place for later use and pass them on to any future user.

Dear customer:

We would like to congratulate you on the purchase of your new high pressure cleaner and thank you for your confidence in our products!

Your choice has fallen on an absolute quality product!
Kärnzle high pressure cleaners are characterized by their convenient and compact design as well as their high suitability for everyday use.

Highest precision and dimensional accuracy in addition to a technology package consisting of a multitude of details mark the difference when it comes to performance, safety and durability.

In order to facilitate handling of the high pressure cleaner, the following pages are intended to further explain its use. The illustrations may be subject to deviation depending on the type of equipment or accessory of high pressure cleaner purchased by you.

Contents	4
Explanatory symbols	5
Safety notes	6
Description of high pressure cleaner	10
General rules	14
Functional details	16
Putting into operation	20
Applying additives	24
Taking out of operation	25
Small repairs - do it yourself	26
Kärnzle accessories	30
EC declaration of conformity	32
Warranty	33
Inspection reports	34

Explanatory symbols used in the operating manual



Failure to observe this note may entail environmental damage.



Note on the use of the high pressure cleaner that failure to adhere to the instructions may cause excessive wear or total breakdown of the K 1152-series.



Warning!
Failure to observe this note may result in serious injuries!

Explanatory symbols affixed to the high pressure cleaner



The high pressure cleaner must be operated in horizontal position!

In case of improper use, the high pressure jets can be very dangerous. Do not direct high pressure jet at persons, animals or active electrical equipment or the high pressure cleaner itself.



The high pressure cleaner may not be connected directly to the public drinking water supply network.

User operating the high pressure cleaner should wear the necessary protective clothing, i.e. waterproof clothing, rubber boots, safety goggles, headwear etc. It is prohibited to use the high pressure cleaner in close vicinity to people lacking suitable protective clothing.

Do not spray against matter containing asbestos or other hazardous substances!

Never spray liquids containing solvents like varnish solvents, petrol, oil or similar liquids! There is an explosion hazard due to spraying such materials!

Due to the high pressure jet, damage may occur on the objects to be cleaned, e.g. car tires; therefore, a minimum distance of 30 cm is to be kept!

Prior to putting the high pressure cleaners into operation, check its components (High pressure hose, power supply cables, safety trigger gun) for any damage. Replace defect or damaged components!

Replacement of the power supply cables is only permitted by use of an original power supply cable of the manufacturer and must be performed by a qualified electrician.

The high pressure cleaner is to be properly used. The user is required to adhere to local requirements and to watch out for the persons in the danger zone!

The high pressure cleaner is not intended for use by persons with reduced physical, sensory or mental capabilities, unless such persons are supervised and capable of perceiving the risks involved in the use of high pressure cleaners!

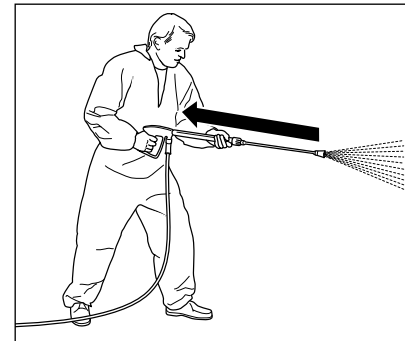

When using high pressure water for cleaning, make sure that there is a clearly noticeable recoil effect on the lance. Therefore ensure a firm footing (see technical data).

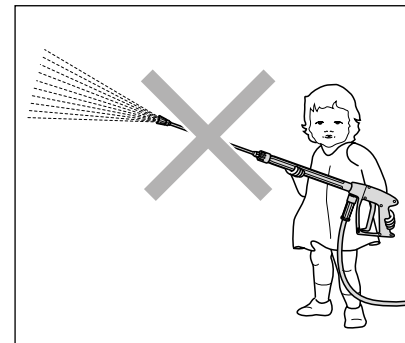

Never allow children or untrained persons to use the high pressure cleaner or to play with it!

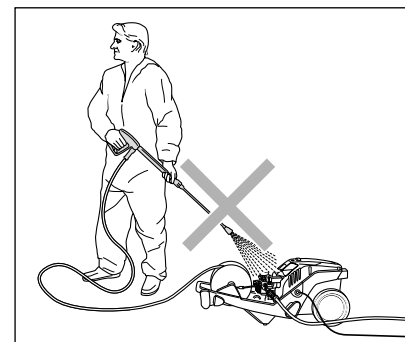

Never direct the high pressure jet at the high pressure cleaner itself!

The high pressure cleaner may not be placed within reach of the high pressure jet spray mist!

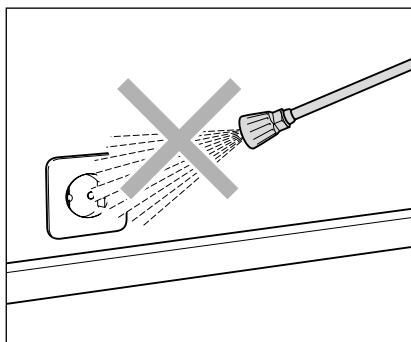

Never direct the high pressure jet at power sockets or any other electrical installations!

Within the working area, all live parts are to be protected from both water jet and spray mist.

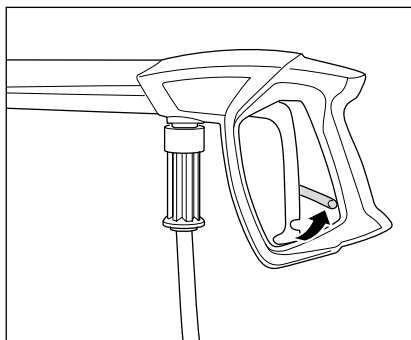

Apply the safety catch on the safety trigger gun after each use in order to prevent unintentional spraying!

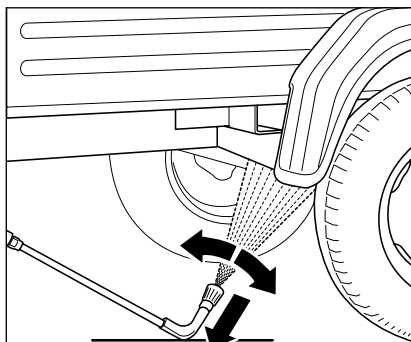

Always pay attention to the underbody lance resting on the surface!
Bear in mind when using a curved or angled spraying lance that there is a significant amount of torque in the recoil!

(the underbody lance is available as optional accessory).

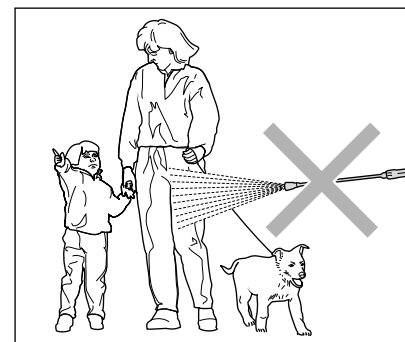

Never direct the high pressure jet at people or animals!

Never direct the high pressure jet at yourself or other persons, not even to clean clothing or shoes.

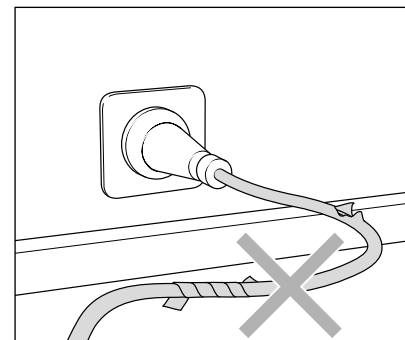

Only use a power supply cable in perfect working order!

Do not damage or improperly repair the power cable (tearing, squeezing, running over, ...).

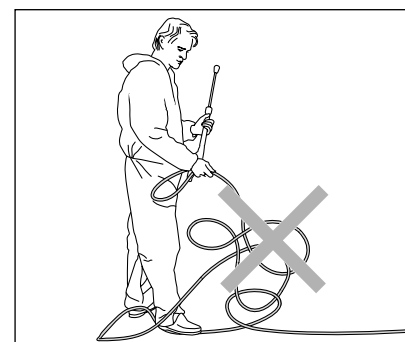

Never pull the high pressure hose if it has formed kinks or "nooses"!

Never pull the high pressure hose over sharp edges!

Design: K 1152-series without hose drum

The K 1152 TS cleaner is a mobile high pressure cleaner with an advanced arrangement system. Please see construction scheme for more details.

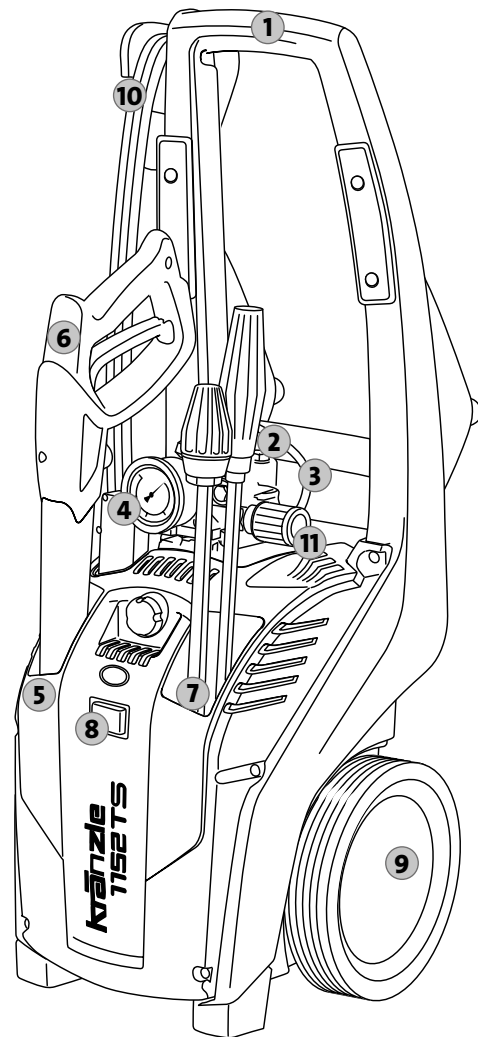

1. Ergonomically shaped handle
2. Pump head made of special brass
3. Cleaning agent injection hose
4. Large stainless steel pressure gauge
5. Storage for safety trigger gun
6. safety trigger gun
7. Lances in storage
8. On/Off switch with motor protection
9. Integrated trolley takes steps and rough ground in its stride
10. Cable reel for the power supply cable
11. infinitely variable pressure and quantity regulation

This is what you have purchased: K 1152-series without hose drum

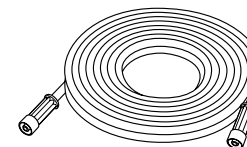
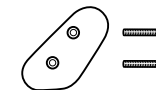
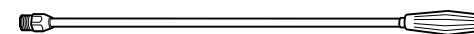
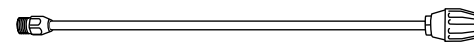
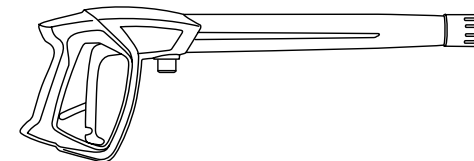
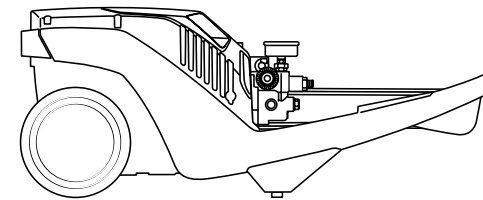

1. Kränzle high pressure cleaner K 1152 TS
2. safety trigger gun with screwing
3. Dirtkiller lance with stainless steel pipe (optional)
4. Vario-Jet lance with stainless steel pipe
5. Crank handle with two fastening screws for the power supply cable
6. operating manual spare parts list
7. high pressure hose

Design: K 1152-series with hose drum

The K 1152 TST cleaner is a mobile high pressure cleaner with an advanced arrangement system. Please see construction scheme for more details.

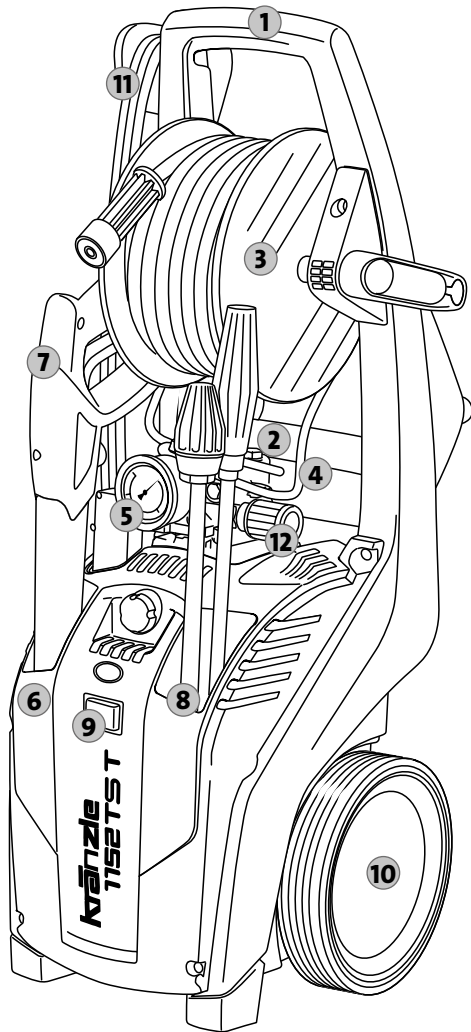

1. Ergonomically shaped handle
2. Pump head made of special brass
3. Hose drum with 15 m steel weave high pressure hose
4. Cleaning agent injection hose
5. Large stainless steel pressure gauge
6. Storage for safety trigger gun
7. safety trigger gun
8. Lances in storage
9. On/Off switch with motor protection
10. Integrated trolley takes steps and rough ground in its stride
11. Cable reel for the power supply cable
12. infinitely variable pressure and quantity regulation

This is what you have purchased: K 1152-series with hose drum

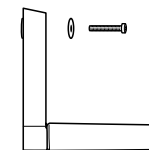
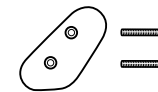
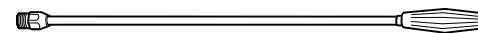
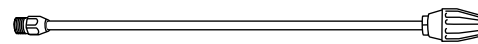
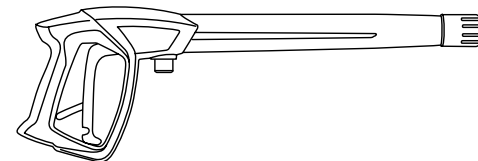
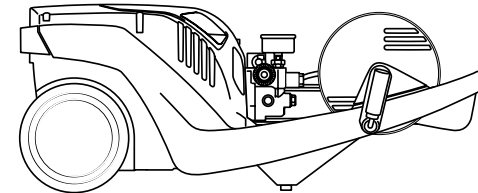

1. Kränzle high pressure cleaner K 1152 TST
2. safety trigger gun with screwing
3. Dirtkiller lance with stainless steel pipe
4. Vario-Jet lance with stainless steel pipe
5. Crank handle with two fastening screws for the power supply cable
6. operating manual spare parts list
7. Crank handle with fastening screw

Range of application

Use high pressure cleaner for cleaning purposes only using high pressure jet with or without cleaning detergent.



Environmental, refuse disposal and water protection regulations must be observed!

Inspections

The high pressure cleaner must be inspected according to the “Guidelines for Liquid Spray Devices” at least once every 12 months by a qualified person, to ensure that continued safe operation is guaranteed. The results of the inspection are to be recorded in writing (see Inspection reports).



High pressure cleaners used for commercial purposes have to be checked by a qualified person at least every 12 months!

Accident prevention

The high pressure cleaner is designed for accidents to be impossible if used correctly. The user is to be notified of the risk of injury from hot machine parts and the high pressure jet. The “Guidelines for Liquid Spray Devices” must be complied with.

Oil change

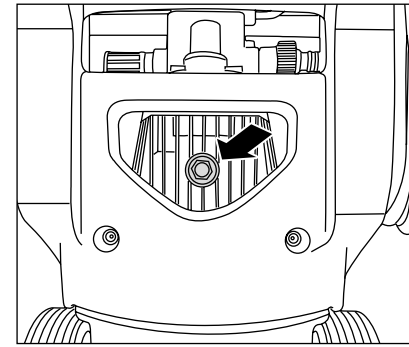

The first oil change should be carried out after approximately **50 operating hours**, then every year or after 250 operating hours. If the oil turns grey or white, you must change the oil. In case of exchanging oil being required, the oil drain screw must be opened above a container and the high pressure cleaner be emptied. The oil is to be caught in the reservoir and disposed of in an approved manner.

New oil: 0.25 l

Kränzle Gear Oil (Item no. 40.092 2)
or Motor oil W 15/40.



Oil leakage

If oil leaks contact your nearest after-sales service (dealer) at once. (environmental damage, damage to the transmission).



In case of increased humidity or fluctuations in temperature development of condensed water is possible. If the oil turns grey or white, you must change it.

Please note: Lack of water

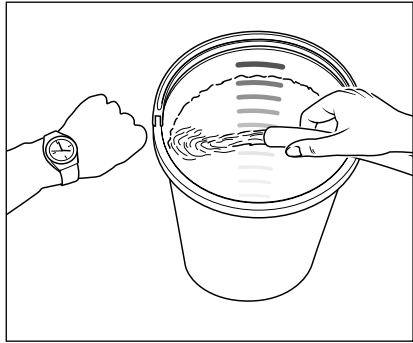

Lack of water occurs more often than you probably believe. The more powerful a high pressure cleaner is the greater is the danger that a lack of water occurs. If there is only an insufficient amount of water available, cavitation (water-gas mixture) arises inside the high pressure pump, which is normally noticed too late or even not at all. **The high pressure pump will be destroyed.** Please check the available quantity of water by filling a bucket with liter scale for one minute.

Required minimum quantity of water (see technical data).



If the metered quantity of water is too small, you have to use a different water connection, guaranteeing the necessary output. Lack of water leads to an accelerated wear of the joints (no warranty).

Water supply



Please pay attention to the regulations of your waterworks company! In accordance with DIN EN 61770, the high pressure cleaner may not be directly connected to the public drinking water supply lines. A brief connection however is permissible according to DVGW (German Association for Gas and Water Affairs) if a non-return valve with tube ventilator (Kränzle order no. 41.016 4) is built into the water supply. **Once the water has passed through the non-return valve it is no longer considered as drinking water.** Also indirect connection to the public drinking water supply lines is permissible by way of free emission in accordance with EN 61 770; e.g. by using a reservoir with a float valve. Direct connection to a non-drinking water supply line is permissible.

Insufficient quantity of electricity

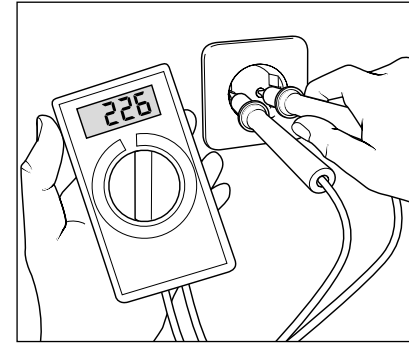

If there are too many collectors in your proximity connected to the network at the same time, the available voltage and the current intensity may decline. Consequently the motor of the high pressure cleaner does not start or even blows. The power supply may also be insufficient if the power supply cable is too long or too thin. If extension cables are too long, this may lead to a voltage drop causing malfunctions or start-up difficulties.



Check the line fusing and have the voltage and the available current intensity checked by an expert in case of uncertainty (see technical data).

Electrical connection

The high pressure cleaner is supplied with a 5 meters long power supply cable. The mains plug must be fitted to a standard grounded socket with a **30 mA** residual current operated device. The socket must be protected with a **16 A** fuse on the mains side. When using an extension cable, **this must have an earthed lead** which is properly connected to the socket. The conductors in the extension cable must have a minimum cross section of **1.5 mm²**. Plug connections must be of a spray-proof design, and may not be located on a wet floor. For extension cables of more than **10 m** in length, the minimum cross-section must be **2.5 mm²**! When using a cable drum, the power supply cable always must be unwound all the way.

Water and cleaning system

Water can be connected at mains pressure to the high pressure pump. The water is then forced under pressure by the high pressure pump to the lance. The high pressure jet is formed by the nozzle at the end of the lance.



Environmental, refuse disposal and water protection regulations must be observed!

Safety jet pipe with safety trigger gun

The high pressure cleaner can only be operated when the trigger of the safety deactivation trigger gun's trigger is actuated. When the trigger is pulled, the safety trigger gun opens. The liquid is then transported to the nozzle. The spray pressure increases and quickly reaches the operating pressure. When the trigger is released, the safety trigger gun closes and any further spraying of liquid from the safety jet pipe is prevented. The stainless steel pressure gauge must show 0 bar. The increase in pressure when the safety trigger gun is closed causes the pressure control valve-safety valve to open. The motor is switched off by the pressure switch. When the safety trigger gun is opened, the pressure control valve - safety valve closes, the motor is started and the high pressure pump resumes pressure spraying from the safety jet pipe with the selected operating pressure.



The safety trigger gun is a safety device. Repairs should only be performed by qualified persons. Should replacement parts be required, use only components authorized by the manufacturer.

Pressure control valve - safety valve

The pressure control valve - safety valve protects the high pressure cleaner from a build up of excess pressure, and is designed not to permit an excess pressure to be selected for operation. The limit nut on the handle is sealed with a spray coating. The operating pressure and spray rate can be steplessly adjusted by turning the handle.



Replacements, repairs, new adjustments and sealing should only be performed by qualified persons.

Motor protection switch

Motor is protected against overload by means of a motor protection switch. In case of motor overload or blocking, the motor of the high pressure cleaner switches off automatically. If motor tends to switch off repeatedly, make sure to detect and remedy the cause of the failure.



Replacements and inspection work should only be performed by qualified persons **when the high pressure cleaner is disconnected from the power supply**, i.e. with plug pulled out from the electrical socket.

Totalstop system

The K 1152-series features a totalstop system. If the main switch is switched on, the motor is started via a pressure switch when opening the safety trigger gun. When closing the safety trigger gun the motor is switched off immediately.

High pressure hose and spray device

The high pressure hose and spray device which are part of the K 1152-series equipment, are made of high quality material and engineered to conform with the operating conditions of the high pressure cleaner and are duly labeled.



If replacement parts are required, only such parts that are authorized by the manufacturer may be used. The warranty is automatically void if spare parts of third-party providers are used! The high pressure hose and spray device must be connected in a pressure-tight manner (without leakage).



The high pressure hose may not be driven over, pulled excessively, or twisted. The high pressure hose may under no circumstances be pulled over sharp edges. Defective high pressure hoses must not be repaired (acc. to DIN 20022) but have to be replaced by new hoses approved by the manufacturer.



Prior to putting the high pressure cleaner into operation make sure that all safety instructions be observed.

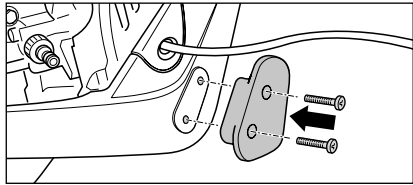

1. Use the supplied screws to fasten the lower cable retractor of the power supply cable in the place provided on the frame.

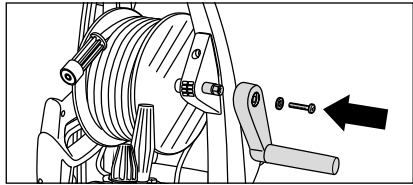

2. For high pressure cleaners with hose drum the enclosed hand crank must be applied prior to first operation. For this purpose, please set up the high pressure cleaner. Plug the hand crank onto the hexagon and attach it with the enclosed screw and washer.

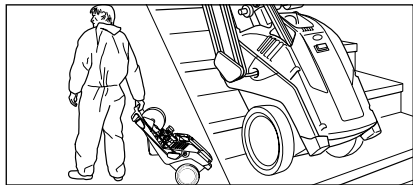

3. Move high pressure cleaner to the job site. The K 1152-series is a movable high pressure cleaner with sturdy trolleys ideally suited for difficult terrain and stairs.



The high pressure cleaner must be operated in horizontal position!



It is imperative that safety instructions be observed during use of the high pressure cleaner.



Neither set up or operate the K 1152-series in rooms where there is a risk of fire or explosion nor put it into puddles. Do not use the high pressure cleaner under water. If, none the less, the high pressure cleaner is operated in a hazardous area, the applicable safety regulations are to be observed.

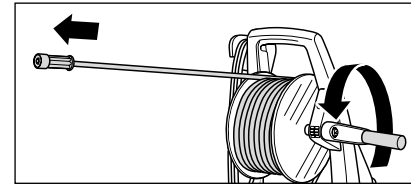

4. Unwind high pressure hose straight and without nooses. For high pressure cleaners with hose drum, however, it must be uncoiled completely. (When extending the high-pressure hose please consider the maximum length of 20 m!)

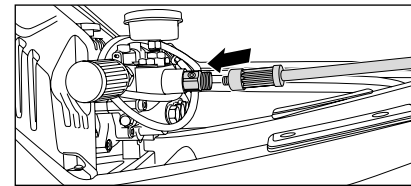

5. **Only for TS high pressure cleaners:** For high pressure cleaners without hose drum the high pressure hose included in the scope of the delivery must be screwed with the pump outlet in a tight and pressure tight manner.

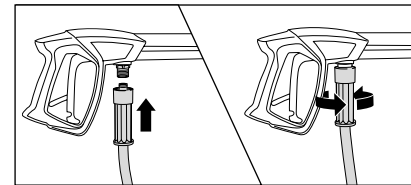

6. Tightly screw together high pressure hose and safety trigger gun.

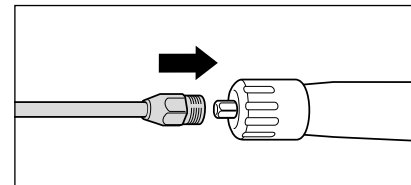

7. Lance on to safety trigger gun.

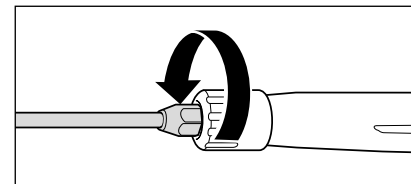

8. Screw together lance and safety trigger gun pressure tightly.

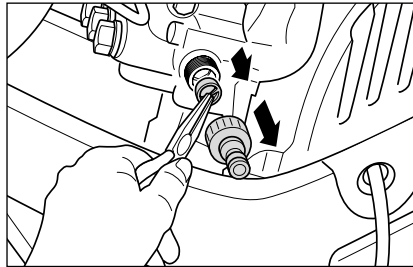

9. Check water inlet filter for cleanliness prior to putting the high pressure cleaner into operation.

Manually unscrew plug-in coupling. Take out the water inlet filter using needle nose pliers and thoroughly rinse it with clear water and clean it with the other parts.



Check the water inlet sieve for damage. Do not operate the high pressure cleaner without or with a damaged filter.

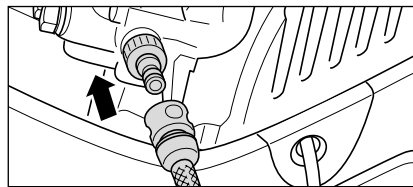

10. Connect the water hose to water inlet sieve. The high pressure cleaner may be connected to a water mains (1-10 bar pre-pressure) with either cold or hot water (up to 60 °C).



Be careful when using hot water!

When running your high pressure cleaner with hot water of 60 °C raised temperatures occur. Do not touch the metal parts of the high pressure cleaner without safety gloves!

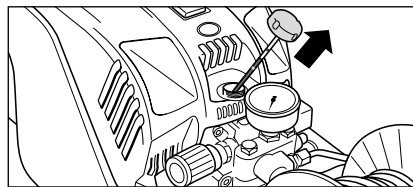

11. Each time check oil level at the oil dipstick prior to putting the high pressure cleaner into operation. (Take care that cleaner is in horizontal position!) Oil level must reach until the upper edge of marking "OK".

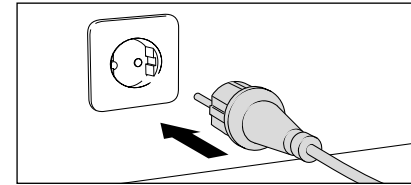

12. Connect to circuit (see technical data).



Do not touch the mains plug or any live parts with wet or moist hands.

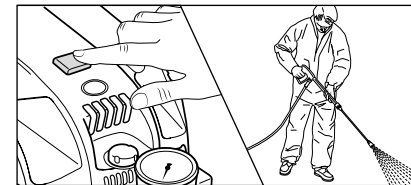

13. Switch on high pressure cleaner with opened safety trigger gun. Bleeding of the high pressure cleaner: Pull and release trigger of safety trigger gun several times. Start cleaning task.

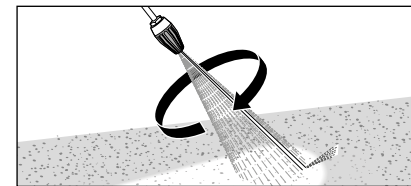

14. When using the filth killer lance make sure that lance points downward when starting.

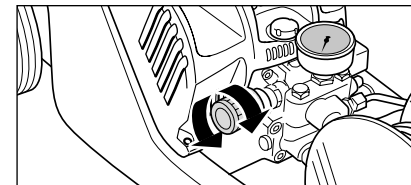

15. Adjust operating pressure infinitely using the rotary handle. The maximum pressure is factory-set.

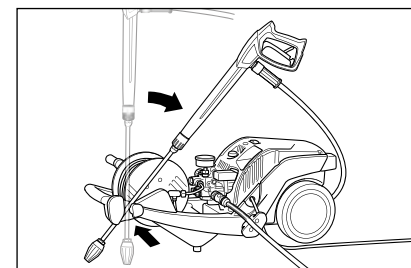

16. The K 1152-series units are equipped with a support for the safety trigger gun with lance during breaks.

Suction of additives

For K 1152-series a built-in injector provides the facility to suck in additives. By pushing the Vario-Jet lance to the front the high pressure cleaner is adjusted to low pressure and a vacuum is built up in the injector. Thus the additives can be sucked in via the connected suction hose with filter.

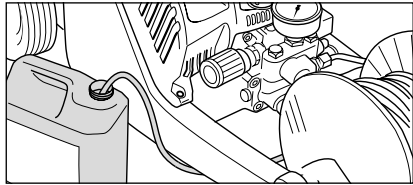

1. Place chemical filter into container with additives

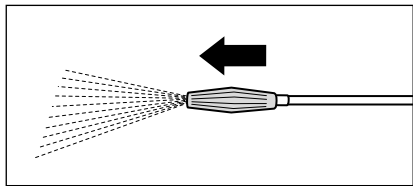

2. To reach the low pressure push Vario nozzle to the front so that the injector can suck in the additives.

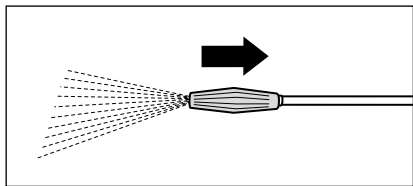

3. When pushing the Vario nozzle backwards, chemical supply is automatically stopped, high pressure cleaner changes to high pressure mode. Let additives take effect and then spray off with high pressure.



The pH value neutral 7-9 is prescribed for the additive. Only use additive suitable for high pressure cleaners. Observe specifications of detergent manufacturer! E.g.: protective equipment, rules for waste water treatment etc.



Attention solvents!

Never suck in liquids containing solvents like varnish solvents, petrol, oil or similar liquids! Seals inside the high pressure cleaner are not resistant against solvents! The spray mist of solvents is highly inflammable, explosive and poisonous.



1. Switch off the high pressure cleaner
2. Cut off the water supply
3. Open the safety trigger gun catch briefly until the pressure is released
4. Apply safety catch on the trigger gun
5. Remove high pressure hose and safety trigger gun
6. Emptying high pressure pump: Hold high pressure hose and switch motor on until water jet stops escaping at the outlet.
7. Pull the plug from the socket
8. Clean high pressure hose and wind up without loops
9. Clean and wind up the power supply cable
10. Clean the water inlet sieve
11. Store high pressure cleaners in frost-free rooms in winter

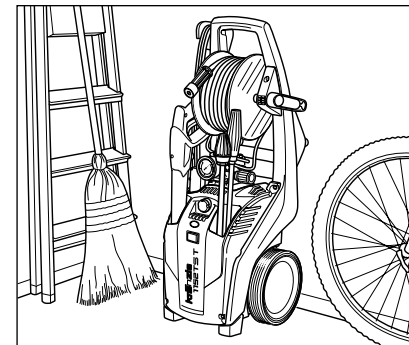

Due to their small base, the compact and mobile Kränzle high pressure cleaners are easy to store.

Problem

No water from nozzle although the high pressure cleaner is running.
The stainless steel pressure gauge shows full pressure.

Cause

Most likely the nozzle is blocked.

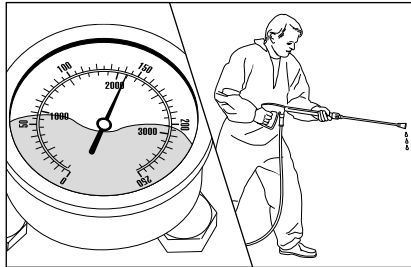

The stainless steel pressure gauge shows full pressure, but from the nozzle comes only little water or no water at all.

(Inside the stainless steel pressure gauge is no water but a filling with glycol to damp the vibration of the pointer.)

Proceeding:

Switch off the high pressure cleaner. Pull plug from the socket. Operate safety trigger gun catch several times to decrease the pressure.

Unscrew safety trigger gun and lance first, then rinse high pressure hose to remove possible soiling.

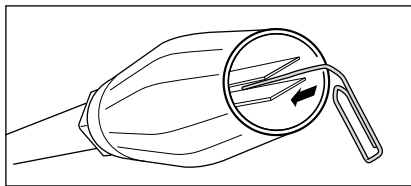

Check water inlet filter for soiling.

If the problem still exists, take wire (paper clip) and push through nozzle opening. If cleaning by means of a wire is not successful, replace lance.



Pull plug from socket prior to starting any repair work!

Problem

Irregular jet from nozzle.
The stainless steel pressure gauge shows low pressure.

Cause

Most likely the valves are soiled or sticky.

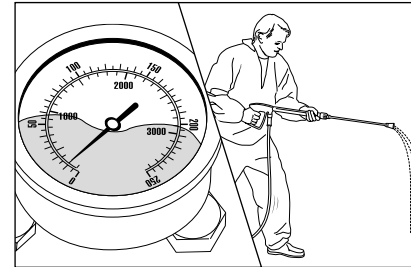

The stainless steel pressure gauge shows low pressure despite fully turned up pressure regulation. The water from the lance comes in squirts. The high pressure hose vibrates.

(Inside the stainless steel pressure gauge is no water but a filling with glycol to damp the vibration of the pointer.)

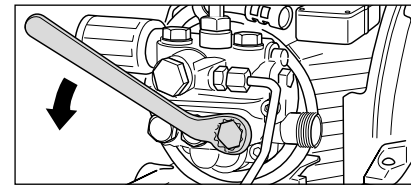

Proceeding:

Unscrew all 6 valves, one after the other (hexagonal brass screws, 3 in a row, vertically and horizontally)

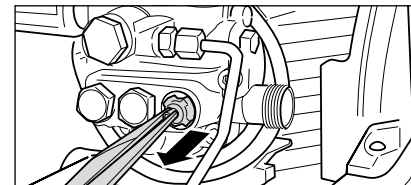

Take out valve body and O-ring by means of needle nose pliers. Check O-ring for damage. In case of a damage the O-ring has to be replaced.

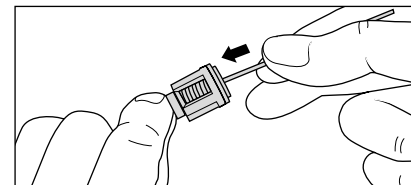

Take a wire (paper clip) and clean valves under running water.

Do not forget the O-ring during reassembly!

Problem

After closing the safety trigger gun the high pressure cleaner keeps switching on and off.
The stainless steel pressure gauge continuously displays full pressure.

Possible cause No. 1

Leakage.

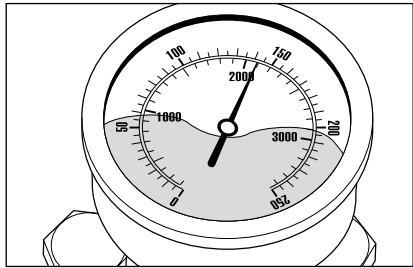

Having closed the trigger gun with safety catch, the high pressure cleaner must shut down and the stainless steel pressure gauge must show „0“ bar. If not shut down and the stainless steel pressure gauge continuously shows full pressure, this could be due to leakage at the high pressure pump, at the pressure switch, at the high pressure hose or at the trigger gun with safety catch.

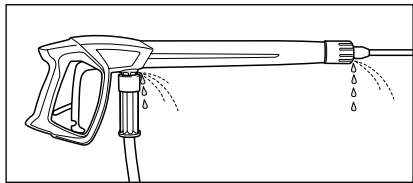

Proceeding:

Check connections from the high pressure cleaner to the high pressure hose and from the high pressure hose to the safety trigger gun and also the connection between lance and safety trigger gun for tightness.

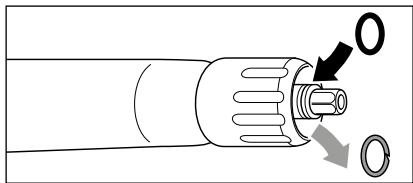

Switch off the high pressure cleaner. Shortly press the trigger of the safety trigger gun to decrease the high pressure cleaner. Unscrew high pressure hose, safety trigger gun and lance and check the O-rings. If the O-rings are damaged they have to be replaced.



In case of a leakage there is no guarantee for possible consequential damages.

Problem

After closing the safety trigger gun the high pressure cleaner keeps switching on and off.
The stainless steel pressure gauge continuously displays full pressure.

Possible cause No. 2

The non-return valve is defective.

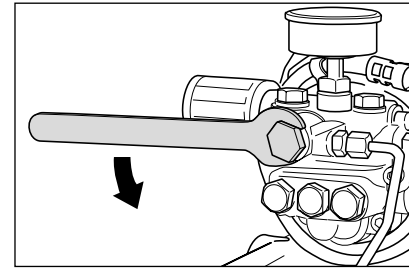

Proceeding:

Switch off the high pressure cleaner and pull plug from socket. Stop water supply. Unscrew pump outlet.

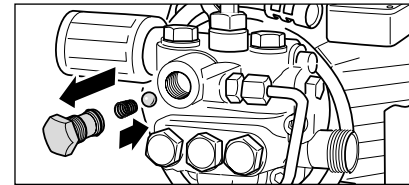

Remove check body and check O-Ring for soiling or damage. Also check seal seat inside pump housing for soiling or damage.

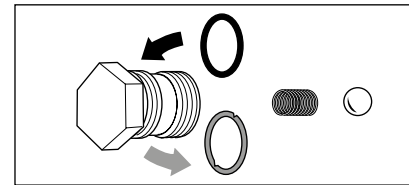

If sealing rings are defective replace O-rings at once.



There is no guarantee if the high pressure pump is damaged by defective O-rings due to air induction or lack of water (cavitation).

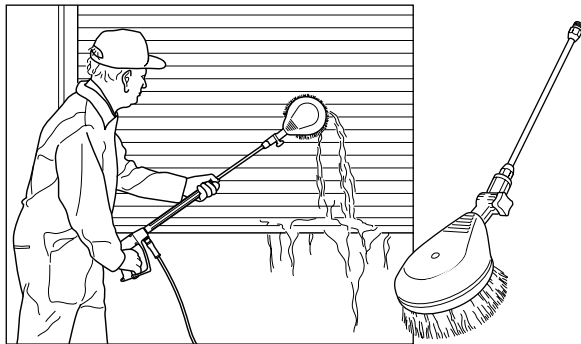

Rotating washing brush

- 400 mm
- Stainless steel extension
- Brush head Ø 180 mm
- Nozzle size 3.2 mm

Item no. 41.050 1

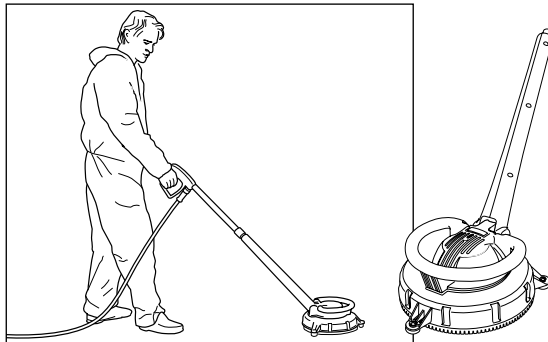

**Floor washer
Round Cleaner UFO**

- Easy execution
- Ø 300 mm
- Nozzle system 045

Item no. 41.850

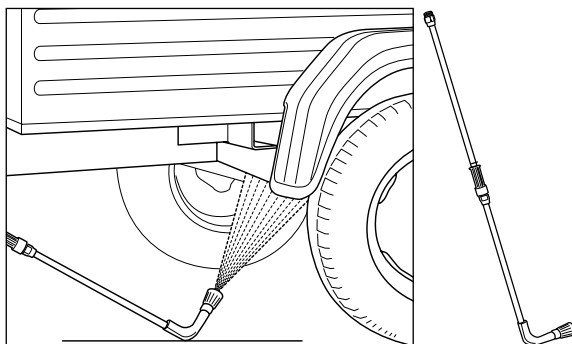

Underbody lance

- Stainless steel pipe
- 1000 mm extension
- Nozzle system 4007

Item no. 41.075

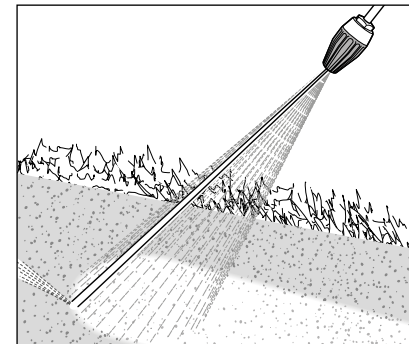

Dirtkiller lance

- Stainless steel pipe 500 mm
- Nozzle system 042

Item no. 41.570-042

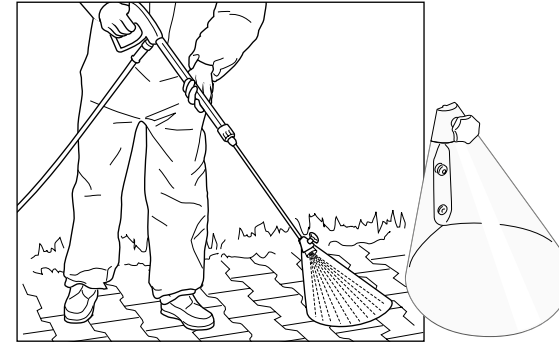

Splash guard

- bottom Ø 220 mm
- For all washing lances

Item no. 41.052

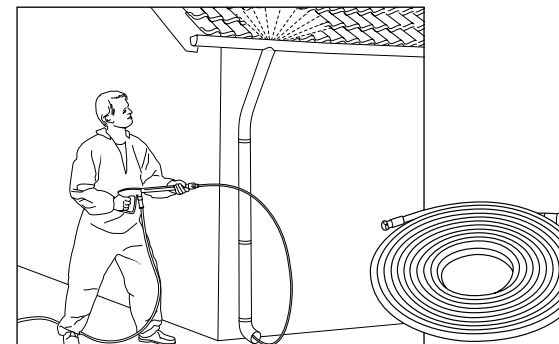

**Pipe cleaning hose
with nozzle**

- in different lengths
- Nozzle system KN 055

10 m Item no. 41.058 1
 15 m Item no. 41.058
 20 m Item no. 41.058 2
 25 m Item no. 41.058 3
 30 m Item no. 41.058 4



The high pressure cleaner accessories are safety components!
 Any warranty will be void if parts not authorised by Kränzle are used.



**Please indicate the technical data of the high pressure cleaner
 (device type) when placing your order.**

We here by declare that the design of the high pressure cleaners: **Kränzle 1152 TS**
Kränzle 1152 TST

Nominal flow: **600 l/h**

technical specifications available from: **Fa. Josef Kränzle GmbH & Co. KG**
Manfred Bauer
Rudolf-Diesel-Str. 20, 89257 Illertissen

comply with the following guidelines and their amendments for high pressure cleaners: **Machinery directive 2006/42/EC**
EMC-directive 2004/108/EC
Noise directive 2005/88/EC,
Art. 13 HP water spraying machines
Annex 3, part B, chapter 27

Sound level measured: **91 dB (A)**
Sound level guaranteed: **93 dB (A)**

Applied conformity assessment procedure: **Annex V, Noise directive 2005/88/EC**

Applied specifications and standards: **EN 60 335-2-79: 2015**
EN 55 014-1: 2006
EN 61 000-3-2: 2014
EN 61 000-3-3: 2013

Josef Kränzle GmbH & Co. KG
Rudolf-Diesel-Straße 20
D - 89257 Illertissen

Illertissen, January 12, 2017

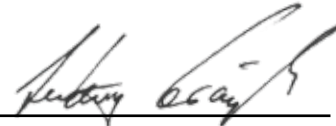

Ludwig Kränzle
(Managing director)

Warranty

Our warranty obligation is understood to exclusively cover material and manufacturing defects, wear is not covered by warranty.

The high pressure cleaner is to be operated in conformity with this Operating manual. The operating manual is deemed to be part of the warranty provisions. This warranty shall only apply on condition of proper use of original-Kränzle component parts and original-Kränzle replacement parts.

With regard to legal warranty claims, the limitation periods of the respective countries shall apply.

In the event of any warranty claims, please have your accessories and purchase voucher ready before contacting your local dealer or the nearest authorized customer service point, which you can also find in the internet under **www.kraenzle.com**.

In case of any modifications on the safety installations or in case of exceeding the temperature and speed limit, any warranty claims shall become invalid - this shall also apply to undervoltage, lack of water and use of wastewater as well as any other faulty or inappropriate operation of the high pressure cleaner.

Pressure gauge, nozzle, valves, sleeves, high pressure hose and spray equipment are wear parts and are not covered by the warranty obligation.

High pressure cleaners for industrial use have to be checked by an expert every 12 months! Inspection report on annually carried out Labour Safety Inspection (UVV) according to the Guidelines for Liquid Spray Equipment. (This inspection sheet serves as proof for the completion of the retest and must be kept carefully!)

Kränzle-test seals: Item no.: UVV200106

Owner: Type:
 Address: Serial no.:
 Repair order no.:

Scope of inspection	o.k.	yes	no	repaired
Type plate (on hand)				
Operating manual (on hand)				
Protective covering, Protective device				
Pressure line (tightness)				
Stainless steel pressure gauge (function)				
Float valve (tightness)				
Spraying device (marking)				
High pressure hose / connector (damage, marking)				
Safety valve opens at 10 % / 20 % exceeding				
power supply cable (damage)				
Protective conductor (connected)				
On / Off switch				
Used chemicals				
Allowed chemicals				

Inspection data	determined value	set value
High pressure nozzle		
Operating pressurebar		
Switch off pressurebar		
protective conductor resistance not exceeded / value		
Insulation		
Leakage current		
Safety trigger gun locked		

Inspection result (check)

- The high pressure cleaner was checked by an expert according to the Guidelines for Liquid Spray Equipment, the defects found have been rectified so that the Labour Safety can be confirmed.
- The high pressure cleaner was checked by an expert according to the Guidelines for Liquid Spray Equipment. The Labour Safety cannot be confirmed unless the defects found are rectified by repair or replacement of the faulty parts.

The next retest according to the Guidelines for Liquid Spray Equipment has to be carried out by: Month Year
 Place, Date Signature

High pressure cleaners for industrial use have to be checked by an expert every 12 months! Inspection report on annually carried out Labour Safety Inspection (UVV) according to the Guidelines for Liquid Spray Equipment. (This inspection sheet serves as proof for the completion of the retest and must be kept carefully!)

Kränzle-test seals: Item no.: UVV200106

Owner: Type:
 Address: Serial no.:
 Repair order no.:

Scope of inspection	o.k.	yes	no	repaired
Type plate (on hand)				
Operating manual (on hand)				
Protective covering, Protective device				
Pressure line (tightness)				
Stainless steel pressure gauge (function)				
Float valve (tightness)				
Spraying device (marking)				
High pressure hose / connector (damage, marking)				
Safety valve opens at 10 % / 20 % exceeding				
power supply cable (damage)				
Protective conductor (connected)				
On / Off switch				
Used chemicals				
Allowed chemicals				

Inspection data	determined value	set value
High pressure nozzle		
Operating pressurebar		
Switch off pressurebar		
protective conductor resistance not exceeded / value		
Insulation		
Leakage current		
Safety trigger gun locked		

Inspection result (check)

- The high pressure cleaner was checked by an expert according to the Guidelines for Liquid Spray Equipment, the defects found have been rectified so that the Labour Safety can be confirmed.
- The high pressure cleaner was checked by an expert according to the Guidelines for Liquid Spray Equipment. The Labour Safety cannot be confirmed unless the defects found are rectified by repair or replacement of the faulty parts.

The next retest according to the Guidelines for Liquid Spray Equipment has to be carried out by: Month Year
 Place, Date Signature



Josef Kränzle GmbH & Co. KG

Rudolf-Diesel-Straße 20
89257 Illertissen (Germany)

sales@kraenzle.com

© Kranzle 20.03.2017 / Subject to technical modifications and errors.

■ **Made**
■ **in**
■ **Germany**