

## EN Operating manual

High-pressure cleaner

**bully 1000 TST**

**bully 1200 TST**



## Operating manual

EN

High-pressure cleaner

**bully 1000 TST**

**bully 1200 TST**

### **Operating manual!**

This manual is a translation of the original manual. Read and conform safety instructions before use! Technical data will be found in the Spare parts list. Please be aware that the spare part list is part of the operating manual. Keep both leaflets for later use or any subsequent owners.

## Dear customer:

We would like to congratulate you on the purchase of your new high-pressure cleaner and thank you for your confidence in our products!

Your choice has fallen on an absolute quality product! Kränzle high-pressure cleaners are characterized by their convenient and compact design as well as their high suitability for everyday use.

Highest precision and dimensional accuracy in addition to a technology package consisting of a multitude of details mark the difference when it comes to performance, safety and durability.

In order to facilitate handling of the high-pressure cleaner, the following pages are intended to further explain its use. The illustrations may be subject to deviation depending on the type of equipment or accessory of high-pressure cleaner purchased by you.

<b>Contents</b> .....	4
<b>Explanatory symbols</b> .....	5
<b>Safety notes</b> .....	6
<b>Description of high-pressure cleaner</b> .....	10
<b>General rules</b> .....	12
<b>Functional details</b> .....	14
<b>Putting into operation</b> .....	18
<b>Direct suction</b> .....	22
<b>Taking out of operation</b> .....	23
<b>Small repairs - do it yourself</b> .....	24
<b>Kränzle accessories</b> .....	28
<b>EU Declaration of Conformity</b> .....	30
<b>Warranty</b> .....	31
<b>Inspection reports</b> .....	32

## Explanatory symbols used in the operating manual



Failure to observe this note may entail environmental damage.



Note on the use of the high-pressure cleaner that failure to adhere to the instructions may cause excessive wear or total breakdown of the bully-series.



Warning!  
Failure to observe this note may result in serious injuries!

## Explanatory symbols affixed to the high-pressure cleaner



In case of improper use, the high-pressure jets can be very dangerous. Do not direct high-pressure jet at persons, animals or active electrical equipment or the high-pressure cleaner itself.



The high-pressure cleaner may not be connected directly to the public drinking water supply network.



Risk of burns due to hot surfaces!



Products marked with this symbol may contain constituents posing a risk to health or the environment if incorrectly disposed of. These products must never be disposed of as household waste.

## Explanatory symbols affixed on the packaging



This symbol denotes recyclable packaging materials which must not be disposed of as household waste. Information on proper disposal will be gathered from the recycling directives issued by your local authority.

User operating the high-pressure cleaner should wear the necessary protective clothing, i.e. waterproof clothing, rubber boots, safety goggles, ear protection headwear etc. It is prohibited to use the high-pressure cleaner in close vicinity to people lacking suitable protective clothing.

Use of high-pressure cleaners may result in aerosols being generated. An aerosol is a mixture of floating solid or liquid particles in a gas. Inhaling aerosol particles may cause damage to health. Employers are under obligation to carry out a hazards assessment in order to determine the necessary protective measures to prevent inhalation of aerosols as governed by the surface due to be cleaned in each case. Respiratory masks, Class FFP 2 or higher, are suitable for protection against aqueous aerosols.

Whenever the high-pressure cleaner is left unattended, the mains disconnect switch must always be switched off.

Do not spray against matter containing asbestos or other hazardous substances!

Never spray flammable liquids or liquids containing solvents such as paint thinners, petrol, oil or similar liquids! Explosion hazard due to spraying such materials!

Due to the high-pressure jet, damage may occur on the objects to be cleaned, e.g. car tires; therefore, a minimum distance of 30 cm is to be kept!

Prior to putting the high-pressure cleaners into operation, check its components (High-pressure hose, power supply cables, safety trigger gun) for any damage. Replace defect or damaged components!

Only use high-pressure hoses, couplings and fittings recommended by Kränzle. Only these accessories ensure safety of the equipment.

If use is made of an extension cable, this must be suitable for outdoor use. In addition care needs to be taken to ensure that the cable is kept dry and that it is situated above the ground. We recommend the use of a cable drum capable of keeping the socket at least 60 mm above the ground.

Replacement of the power supply cables is only permitted by use of an original power supply cable of the manufacturer and must be performed by a qualified electrician.

Safety devices serve to protect the user and must never be de-activated or their function bypassed.

The high-pressure cleaner is to be properly used. The user is required to adhere to local requirements and to watch out for the persons in the danger zone!

If used in elevated positions where there is a risk of the unit falling to the ground, it must be secured against rolling away or tipping over.

The high-pressure cleaner is not designed for use by persons with restricted physical, sensory or mental abilities (including children)!

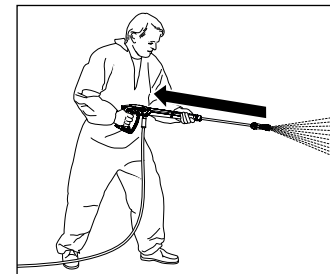

When using high-pressure water for cleaning, make sure that there is a clearly noticeable recoil effect on the lance. Therefore ensure a firm footing (see technical data).

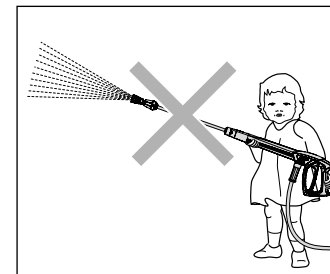

Never allow children or untrained persons to use the high-pressure cleaner or to play with it! Children must be kept under supervision to prevent them from playing with the equipment.

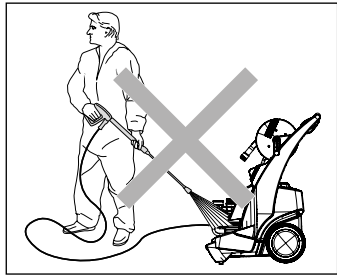

Never direct the high-pressure jet at the high-pressure cleaner itself! The high-pressure cleaner may not be placed within reach of the high-pressure jet spray mist!

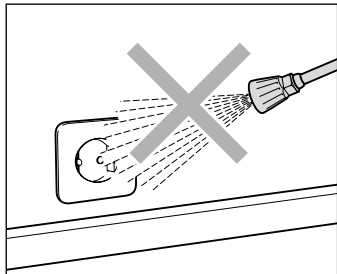

Never direct the high-pressure jet at power sockets or any other electrical installations! Within the working area, all live parts are to be protected from both water jet and spray mist.

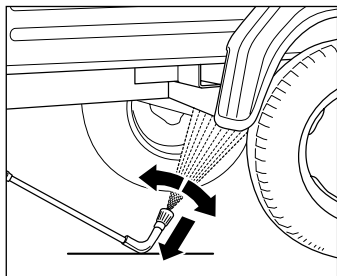

Always pay attention to the underbody lance resting on the surface! Bear in mind when using a curved or angled spraying lance that there is a significant amount of torque in the recoil!

(The underbody lance is available as optional accessory).

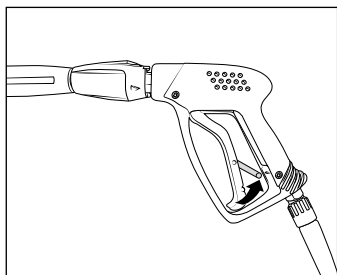

Apply the safety catch on the safety trigger gun after each use in order to prevent unintentional spraying!

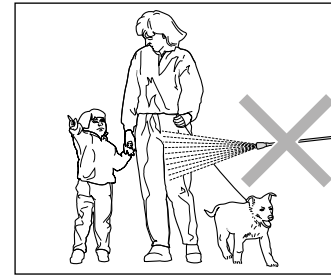

Never direct the high-pressure jet at people or animals! Never direct the high-pressure jet at yourself or other persons, not even to clean clothing or shoes.

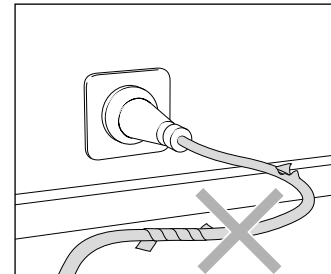

Only use a power supply cable in perfect working order! Do not damage or improperly repair the power cable (tearing, squeezing, running over, ...).

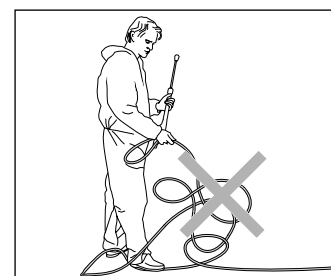

Never pull the high-pressure hose if it has formed kinks or "nooses"! Never pull the high-pressure hose over sharp edges!

**Design: bully-series with hose drum**

The bully 1000 TST and bully 1200 TST is a mobile high-pressure cleaner with an advanced arrangement system. Please see construction scheme for more details.

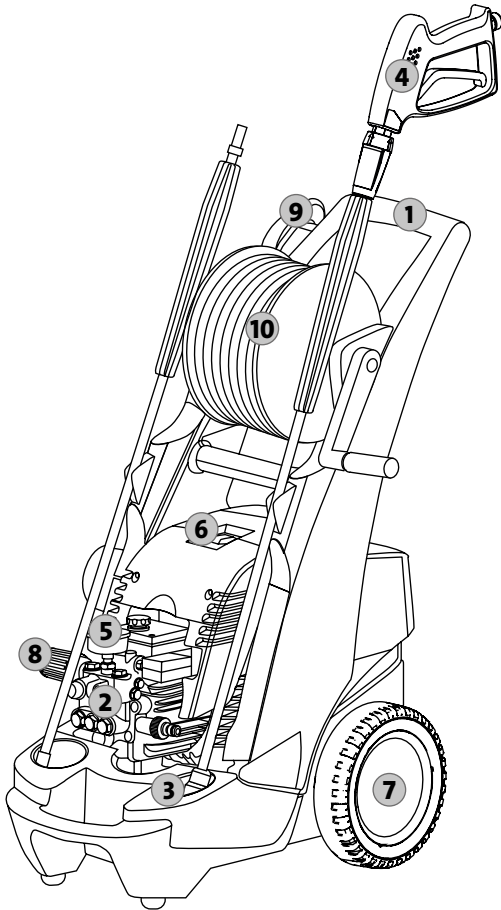

1. Ergonomically shaped handle
2. Pump head made of special brass
3. Storage for safety trigger gun with lance
4. Safety trigger gun
5. Large stainless steel pressure gauge
6. On/Off switch
7. Integrated trolley takes steps and rough ground in its stride
8. Infinitely variable pressure and quantity regulation
9. Cable reel for the power supply cable
10. Hose drum with steel weave high-pressure hose

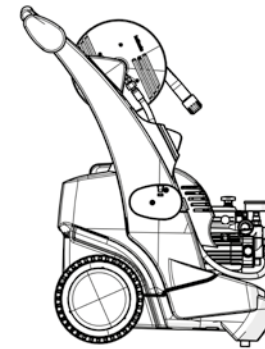
**This is what you have purchased: bully-series with hose drum**

1. Kränzle high-pressure cleaner bully 1000 TST  
bully 1200 TST

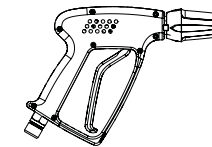

2. Trigger gun with safety catch, short design with quick release coupling



3. Dirtkiller lance with quick release coupling



4. Stainless steel lance with flat jet nozzle and quick release coupling



5. Operating manual  
Spare parts list

### Intended use

This high-pressure cleaner is to be used solely for high-pressure water jet cleaning applications without detergents or low-pressure cleaning work with detergents (e.g. with a foam injector or washing brush).



**Environmental, refuse disposal and water protection regulations must be observed!**

### Inspections

The high-pressure cleaner must be inspected according to the “Guidelines for Liquid Spray Devices” at least once every 12 months by a qualified person, to ensure that continued safe operation is guaranteed. The results of the inspection are to be recorded in writing (see Inspection reports).



**High-pressure cleaners used for commercial purposes have to be checked by a qualified person at least every 12 months!**

### Accident prevention

The high-pressure cleaner is designed for accidents to be impossible if used correctly. The user is to be notified of the risk of injury from hot machine parts and the high-pressure jet. The “Guidelines for Liquid Spray Devices” must be complied with.

### Oil change

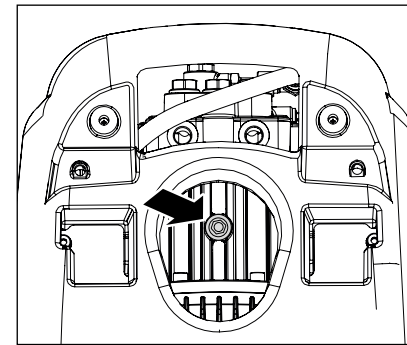

The first oil change should be carried out after approximately **50 operating hours**, then every year or after 250 operating hours. If the oil turns grey or white, you must change the oil. In case of exchanging oil being required, the oil drain screw must be opened above a container and the high-pressure cleaner be emptied. The oil is to be caught in the reservoir and disposed of in an approved manner.

#### New oil: 1.0 l

Kränzle High Performance Gear Oil  
(Ord. no.: 400932)



#### Oil leakage

If oil leaks contact your nearest after-sales service (dealer) at once. (environmental damage, damage to the transmission).



**In case of increased humidity or fluctuations in temperature development of condensed water is possible. If the oil turns grey or white, you must change it.**

### Please note: Lack of water

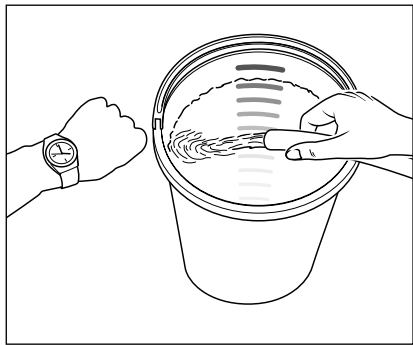

Lack of water occurs more often than you probably believe. The more powerful a high-pressure cleaner is the greater is the danger that a lack of water occurs. If there is only an insufficient amount of water available, cavitation (water-gas mixture) arises inside the high-pressure pump, which is normally noticed too late or even not at all. **The high-pressure pump will be destroyed.** Please check the available quantity of water by filling a bucket with liter scale for one minute.

#### Required minimum quantity of water (see technical data).



**If the metered quantity of water is too small, you have to use a different water connection, guaranteeing the necessary output. Lack of water leads to an accelerated wear of the joints (no warranty).**



**Never let the high-pressure pump run dry for more than 60 seconds.**

### Water supply



Please pay attention to the regulations of your waterworks company! In accordance with DIN EN 61770, the high-pressure cleaner may not be directly connected to the public drinking water supply lines. A brief connection however is permissible according to DVGW (German Association for Gas and Water Affairs) if a non-return valve with tube ventilator (Kränzle order no. 41.016 4) is built into the water supply. **Once the water has passed through the non-return valve it is no longer considered as drinking water.** Also indirect connection to the public drinking water supply lines is permissible by way of free emission in accordance with EN 61 770; e.g. by using a reservoir with a float valve. Direct connection to a non-drinking water supply line is permissible.

### Insufficient quantity of electricity

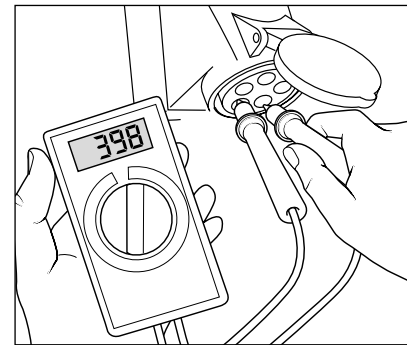

If there are too many collectors in your proximity connected to the network at the same time, the available voltage and the current intensity may decline. Consequently the motor of the high-pressure cleaner does not start or even blows. The power supply may also be insufficient if the power supply cable is too long or too thin. If extension cables are too long, this may lead to a voltage drop causing malfunctions or start-up difficulties.



**Check the line fusing and have the voltage and the available current intensity checked by an expert in case of uncertainty (see technical data).**

### Electrical connection

The high-pressure cleaner is supplied with a power supply cable. The mains plug must be fitted to a standard grounded socket with a **30 mA** residual current operated device. Connection up to the mains must be carried out by a properly trained electrician and must comply with the requirements of IEC60364-1. The socket must be protected with a **16 A** fuse on the mains side. When using an extension cable, **this must have an earthed lead** which is properly connected to the socket. The conductors in the extension cable must have a minimum cross section of **1.5 mm<sup>2</sup>**. Plug connections must be of a spray-proof design, and may not be located on a wet floor. For extension cables of **more than 10 m** in length, the minimum cross-section must be **2.5 mm<sup>2</sup>**! When using a cable drum, the power supply cable always must be unwound all the way.

## Water and cleaning system

Water can be connected at mains pressure to the high-pressure pump. The water is then forced under pressure by the high-pressure pump to the lance. The high-pressure jet is formed by the nozzle at the end of the lance.



**Environmental, refuse disposal and water protection regulations must be observed!**

## Safety jet pipe with safety trigger gun

The high-pressure cleaner can only be operated when the trigger of the safety deactivation trigger gun's trigger is actuated. When the trigger is pulled, the safety trigger gun opens. The liquid is then transported to the nozzle. The spray pressure increases and quickly reaches the operating pressure. When the trigger is released, the safety trigger gun closes and any further spraying of liquid from the safety jet pipe is prevented. The stainless steel pressure gauge must show 0 bar. The increase in pressure when the safety trigger gun is closed causes the pressure control valve-safety valve to open. The motor is switched off by the pressure switch. When the safety trigger gun is opened, the pressure control valve - safety valve closes, the motor is started and the high-pressure pump resumes pressure spraying from the safety jet pipe with the selected operating pressure.



**The safety trigger gun is a safety device. Repairs should only be performed by qualified persons. Should replacement parts be required, use only components authorized by the manufacturer.**

## Pressure control valve - safety valve

The pressure control valve - safety valve protects the high-pressure cleaner from a build up of excess pressure, and is designed not to permit an excess pressure to be selected for operation. The limit nut on the handle is sealed with a spray coating. The operating pressure and spray rate can be steplessly adjusted by turning the handle.



**Replacements, repairs, new adjustments and sealing should only be performed by qualified persons.**

## Motor protection switch

Motor is protected against overload by means of a motor protection switch. In case of motor overload or blocking, the motor of the high-pressure cleaner switches off automatically. If motor tends to switch off repeatedly, make sure to detect and remedy the cause of the failure.



Replacements and inspection work should only be performed by qualified persons **when the high-pressure cleaner is disconnected from the power supply**, i.e. with plug pulled out from the electrical socket.

## Totalstop system

The small quadro series is equipped with a total stop system. After water connection and high-pressure hose connection you switch the high-pressure cleaner at the main switch to "ON", a red signal lights up. If the main switch is switched on, the motor is started via a pressure switch when opening the safety trigger gun. When closing the safety trigger gun the motor is switched off immediately. The high-pressure cleaner remains on standby until the main switch is switched "OFF". After that, the red lights stops.

## High-pressure hose and spray device

The high-pressure hose and spray device which are part of the bully-series equipment, are made of high quality material and engineered to conform with the operating conditions of the high-pressure cleaner and are duly labeled.



If replacement parts are required, only such parts that are authorized by the manufacturer may be used. The warranty is automatically void if spare parts of third-party providers are used! The high-pressure hose and spray device must be connected in a pressure-tight manner (without leakage).



The high-pressure hose may not be driven over, pulled excessively, or twisted. The high-pressure hose may under no circumstances be pulled over sharp edges. Defective high-pressure hoses must not be repaired (acc. to DIN 20022) but have to be replaced by new hoses approved by the manufacturer.



**Prior to putting the high-pressure cleaner into operation make sure that all safety instructions be observed.**

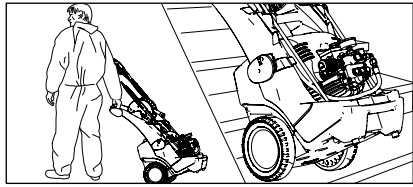

1. Move high-pressure cleaner to the job site. The bully-series is a movable high-pressure cleaner with sturdy trolleys ideally suited for difficult terrain and stairs.



**It is imperative that safety instructions be observed during use of the high-pressure cleaner.**



**Neither set up or operate the bully-series in rooms where there is a risk of fire or explosion nor put it into puddles. Do not use the high-pressure cleaner under water. If, none the less, the high-pressure cleaner is operated in a hazardous area, the applicable safety regulations are to be observed.**

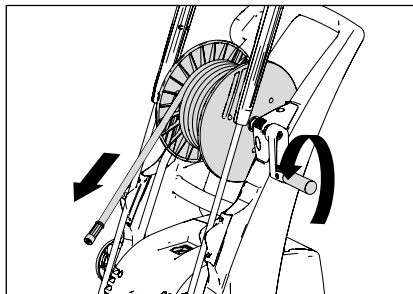

2. For high-pressure cleaners with hose drum, however, it must be uncoiled completely. Unwind high-pressure hose straight and without nooses.

The high-pressure hose may leave signs of abrasion on some floors. Alternatively, please also find non-marking high-pressure hoses in our range.

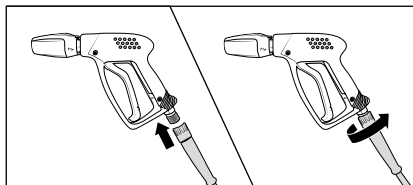

3. Mount the grey rotating screw connection of the high-pressure hose onto the trigger gun incorporating a safety catch. Afterwards screw together ensuring a snug and pressure-tight fit.



**When using high-pressure hose extensions take care that the max. length of 20 m is not exceeded!**

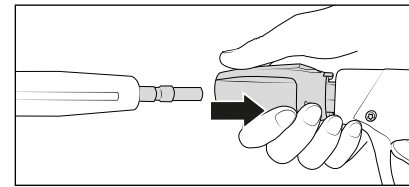

4. First pull back the retaining sleeve of the safety trigger gun, then insert lance into the plug coupling connection of the safety trigger gun.

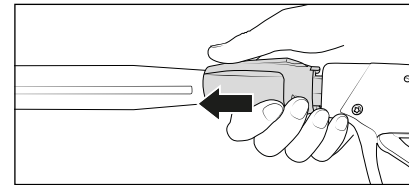

5. After insertion of the lance, release retaining sleeve and make sure that the lance is in a secure position.

**Grease quick release nipple regularly using acid-free grease.**



**The plug coupling must not be actuated/handled during operation! High risk of injury!**



**Prior to insertion, check plug coupling connection of lance for cleanliness (sand, dirt ..) and use clear water to clean, if necessary. Impurities may damage the sealing in the plug coupling.**



**Accessories may only be connected to a Kränzle-approved trigger gun with safety catch.**

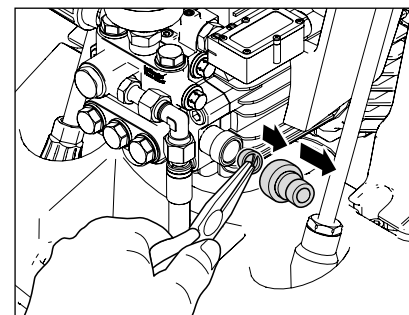

6. **Check water inlet filter for cleanliness prior to putting the high-pressure cleaner into operation.**

Manually unscrew plug-in coupling. Take out the water inlet filter using needle nose pliers and thoroughly rinse it with clear water and clean it with the other parts. If the sieve is dirty, water can not get through and pressure will not build up.



**Check the water inlet sieve for damage. Do not operate the high-pressure cleaner without or with a damaged filter.**

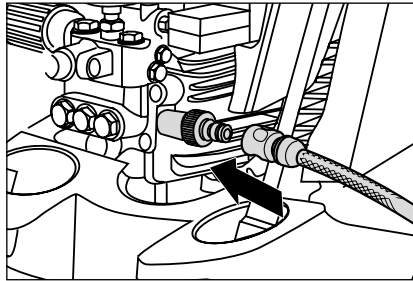

7. Connect water hose to water inlet (minimum requirements; 5 m hose length, cross-section ¾", 10 bar). The high-pressure cleaner may be connected to a water mains (1-10 bar pre-pressure) with either cold or hot water (up to 60 °C). The bully series provides the opportunity of sucking in water out of a container (see direct suction).



**Be careful when using hot water!**

When running your high-pressure cleaner with hot water of 60 °C raised temperatures occur. Do not touch the metal parts of the high-pressure cleaner without safety gloves!

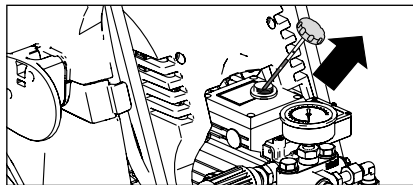

8. **Each time check oil level at the oil dipstick prior to putting the high pressure cleaner into operation.** Oil level must reach until the upper edge of marking "OK".

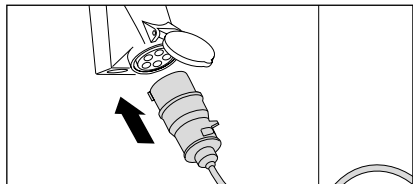

9. Connect to circuit (see technical data).



**Do not touch the mains plug or any live parts with wet or moist hands.**

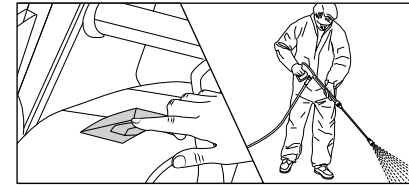

10. Switch on high-pressure cleaner with opened safety trigger gun. Bleeding of the high-pressure cleaner: Pull and release trigger of safety trigger gun several times. Start cleaning task.

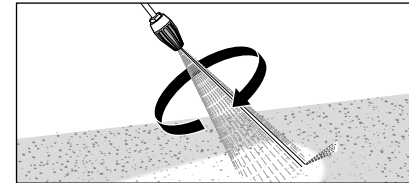

11. When using the filth killer lance make sure that lance points downward when starting.

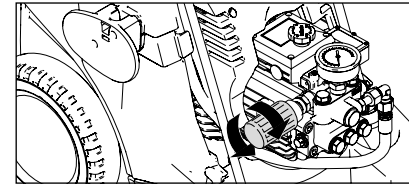

12. Adjust operating pressure infinitely using the rotary handle. The maximum pressure is factory-set.

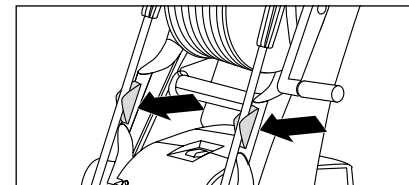

13. The bully-series units are equipped with a support for the safety trigger gun with lance during breaks.

## Direct water extraction

Due to the suction capacity of its high-pressure pump (up to 2.5 m suction height, max. hose length 3 m) this high-pressure cleaner can suck in water for cleaning purposes from separate containers or ponds.

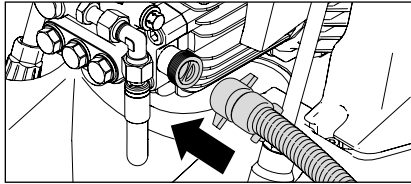

1. Mount suction hose with suction filter (Ord. no.: 150383).

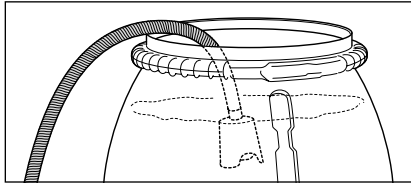

2. Put filled suction hose into the water-filled container and start the cleaning job. **Use clean water only! Never suck in water containing chlorine! Do not suction air!**



**Prior to starting the first suction the high-pressure pump and the suction hose has to be filled with water!**

### Note

Depending on the water quality it may occur after a prolonged standstill that the valves get sticky. Consequently the high-pressure cleaner cannot properly suck in water from a container. In this case connect a hose with pressurized water to the pump inlet. Having started the high-pressure cleaner the pressurized water opens the valves and the machine resumes sucking in water from the container. Now you can carry on with your cleaning task as usual.



1. Switch off the high-pressure cleaner
2. Cut off the water supply
3. Open the safety trigger gun catch briefly until the pressure is released
4. Apply safety catch on the trigger gun
5. Remove high-pressure hose and safety trigger gun
6. Emptying high-pressure pump: Hold high-pressure hose and switch motor on until water jet stops escaping at the outlet.
7. Pull the plug from the socket
8. Clean high-pressure hose and wind up without loops
9. Clean and wind up the power supply cable
10. Clean the water inlet sieve
11. Store high-pressure cleaners in frost-free rooms in winter

## Frost protection

For protecting the high-pressure cleaner against frost please empty it completely. Separate high-pressure cleaner from water supply and switch it on. By opening the trigger gun the high-pressure pump presses water out of the high-pressure cleaner. **However, do not allow the device to operate without water for more than one minute.**

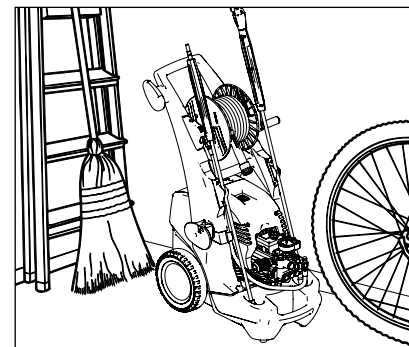

Due to their small base, the compact and mobile Kränzle high-pressure cleaners are easy to store.

**Problem**

No water from nozzle although the high-pressure cleaner is running.  
The stainless steel pressure gauge shows full pressure.

**Cause**

**Most likely the nozzle is blocked.**

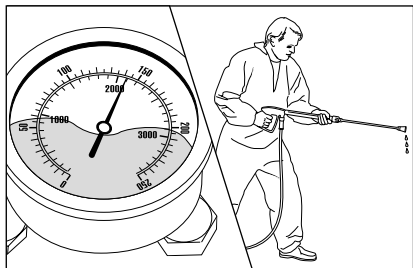

The stainless steel pressure gauge shows full pressure, but from the nozzle comes only little water or no water at all.

(Inside the stainless steel pressure gauge is no water but a filling with glycerin to damp the vibration of the pointer.)

**Proceeding:**

Switch off the high-pressure cleaner. Pull plug from the socket. Operate safety trigger gun catch several times to decrease the pressure.

Remove safety trigger gun and lance first, then rinse high-pressure hose to remove possible soiling.

Check water inlet filter for soiling.

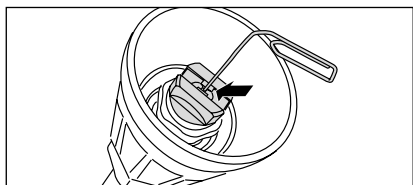

If the problem still exists, take wire (paper clip) and push through nozzle opening. If this procedure is not successful, the nozzle has to be replaced.



**Pull plug from socket prior to starting any repair work!**

**Problem**

Irregular jet from nozzle.  
The stainless steel pressure gauge shows low pressure.

**Cause**

**Most likely the valves are soiled or sticky.**

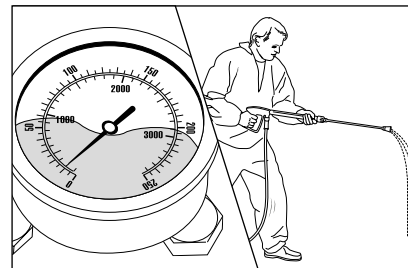

The stainless steel pressure gauge shows low pressure despite fully turned up pressure regulation. The water from the lance comes in squirts. The high-pressure hose vibrates.

(Inside the stainless steel pressure gauge is no water but a filling with glycerin to damp the vibration of the pointer.)

**Proceeding:**

Unscrew all 6 valves, one after the other (hexagonal brass screws, 3 in a row, vertically and horizontally)

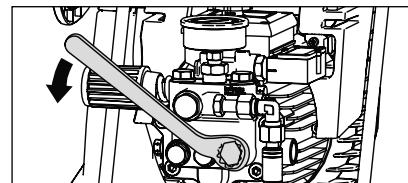

Take out valve body and O-ring by means of needle nose pliers. Check O-ring for damage. In case of a damage the O-ring has to be replaced.

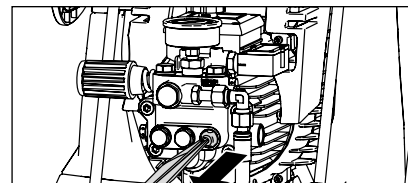

Take a wire (paper clip) and clean valves under running water.

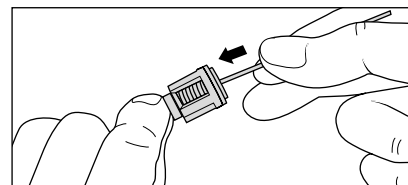

Do not forget the O-ring during reassembly!

**Problem**

After closing the safety trigger gun the high-pressure cleaner keeps switching on and off.  
The stainless steel pressure gauge continuously displays full pressure.

**Possible cause No. 1**

**Leakage.**

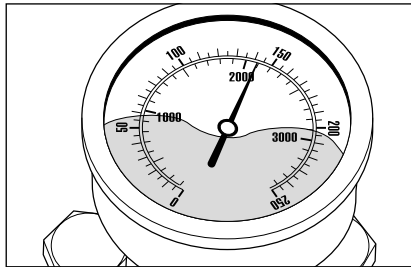

Having closed the trigger gun with safety catch, the high-pressure cleaner must shut down and the stainless steel pressure gauge must show „0“ bar. If not shut down and the stainless steel pressure gauge continuously shows full pressure, this could be due to leakage at the high-pressure pump, at the pressure switch, at the high-pressure hose or at the trigger gun with safety catch.

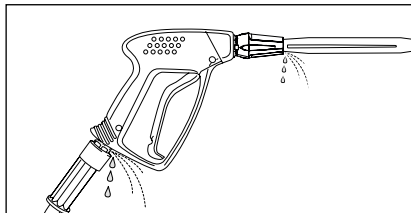

**Proceeding:**

Check connections from the high-pressure cleaner to the high-pressure hose and from the high-pressure hose to the safety trigger gun and also the connection between lance and safety trigger gun for tightness.

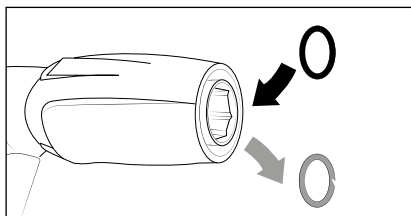

Switch off the cleaner. Shortly press the trigger of the trigger gun with safety catch to decrease the pressure. Remove high-pressure hose, trigger gun with safety catch and lance and check the O-rings. If the O-rings are damaged they have to be replaced.



**In case of a leakage there is no guarantee for possible consequential damages.**

**Problem**

After closing the safety trigger gun the high-pressure cleaner keeps switching on and off.  
The stainless steel pressure gauge continuously displays full pressure.

**Possible cause No. 2**

**The non-return valve is defective.**

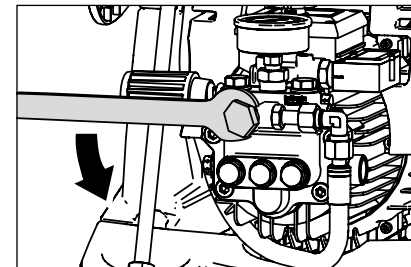

**Proceeding:**

Switch off the high-pressure cleaner and pull plug from socket. Stop water supply. Operate safety trigger gun catch several times to decrease the pressure. Unscrew pump outlet.

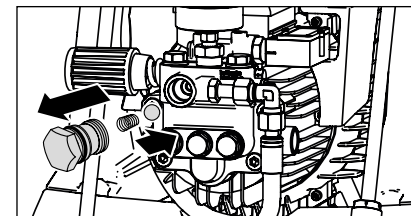

Remove check body and check O-Ring for soiling or damage. Also check seal seat inside pump housing for soiling or damage.

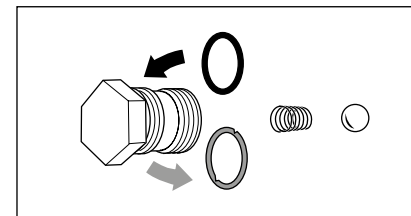

If sealing rings are defective replace O-rings at once.



**There is no guarantee if the high-pressure pump is damaged by defective O-rings due to air induction or lack of water (cavitation).**



**Rotating washing brush**

- Stainless steel pipe
- 1000 mm
- Brush head Ø 180 mm
- Nozzle size 3.2 mm
- With anti-twist protection
- With plug-in nipple

Ord. no.: 410507

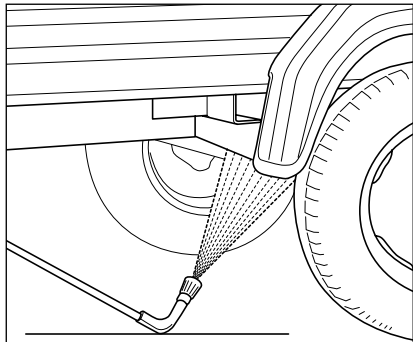
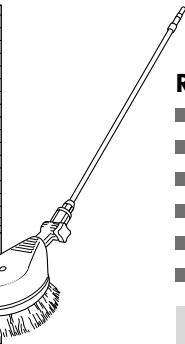

**Underbody lance**

- Stainless steel pipe
- 1000 mm
- Nozzle system 4007
- With anti-twist protection
- With plug-in nipple

Ord. no.: 410755

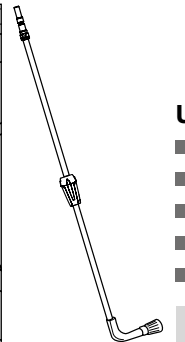

**Double lance**

- With ISO handle
- Low pressure nozzle D3035 as standard
- With anti-twist protection
- With plug-in nipple

Ord. no.: 12133



**Foam injector**

- 1 litre, with container
- Dosage in 5 levels
- With plug-in nipple

Ord. no.: 135303



**Splash guard**

- L: 280 mm x W: 190 mm
- For all washing lances

Ord. no.: 132600

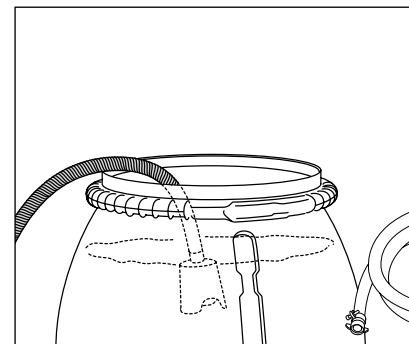

**Suction hose with suction filter**

- With return valve
- Hose length 3 m

Ord. no.: 150383



**The high-pressure cleaner accessories are safety components!**  
Any warranty will be void if parts not authorised by Kränzle are used.



**Please indicate the technical data of the high-pressure cleaner (device type) when placing your order.**

We here by declare that the design of the high-pressure cleaners: **bully 1000 TST**  
**bully 1200 TST**

Nominal flow: **bully 1000 TST: 960 l/h**  
**bully 1200 TST: 1140 l/h**

technical specifications available from: **Fa. Josef Kränzle GmbH & Co. KG**  
**Manfred Bauer**  
**Rudolf-Diesel-Str. 20, 89257 Illertissen**

comply with the following guidelines and their amendments for high-pressure cleaners: **Machinery Directive 2006/42/EC**  
**EMC Directive 2014/30/EU**  
**ROHS Directive 2011/65/EU**  
**Outdoor Directive 2000/14/EC**

Noise pressure level, typical: **89 dB (A)**  
Noise pressure level, guaranteed: **91 dB (A)**

Applied conformity assessment procedure: **Annex V, Outdoor Directive 2000/14/EC**

Applied specifications and standards: **EN 60335-1:2012/A13:2017**  
**EN 60335-2-79:2012**  
**EN 62233: 2008**  
**EN 55014-1: 2006+A1: 2009+A2: 2011**  
**EN 55014-2: 2015**  
**EN 61000-3-2: 2014**  
**EN 61000-3-3: 2013**

Josef Kränzle GmbH & Co. KG  
Rudolf-Diesel-Straße 20  
89257 Illertissen (Germany)

Illertissen, 2019-04-05

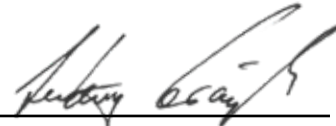

Ludwig Kränzle  
(Managing director)

The warranty obligation of Josef Kränzle GmbH & Co. KG towards the dealer from whom you have purchased this Kränzle high-pressure cleaner (= product) applies to material faults only such as material and manufacturing defects.

Defects attributable to long and frequent use of the product, typically arising due to the age of the high-pressure cleaner and intensity of its use are defined as normal wear in respect of product components. Purchaser's rights to assert claims for such defects are ruled out. Parts subject to wear include in particular the pressure gauge, nozzle, valves, sleeves, high-pressure hose and spray equipment.

The product is to be operated in conformity with this operating manual. The operating manual is deemed to be part of the warranty provisions.

Any changes made to the safety devices of the product or instances of maloperation – such as exceeding the temperature and speed limits, undervoltage, insufficient water supply and sewage water, or failure to use the product for the intended purpose – may result in damage occurring to the product. Such damage is not deemed to constitute any material defect.

Should the use of accessories or spares other than original Kränzle component parts and original Kränzle replacement parts be the cause of defects on our product, this may lead to all warranty claims becoming null and void. Only the use of original Kränzle replacement parts matching the relevant Kränzle high-pressure cleaner provides adequate assurance for safe and trouble-free operation of the Kränzle high-pressure cleaner.

With regard to legal warranty claims, the limitation periods of the respective countries shall apply.

Where warranty claims apply to any other defects, please contact your local dealer, presenting the accessories together with your purchase receipt, or the nearest authorised service centre. This can also be found on the internet under **www.kraenzle.com**.

**High-pressure cleaners for industrial use have to be checked by an expert every 12 months!** Inspection report on annually carried out Labour Safety Inspection (UVV) according to the Guidelines for Liquid Spray Equipment. (This inspection sheet serves as proof for the completion of the retest and must be kept carefully!)

Kränzle-test seals: Item no.: UVV200106

Owner: ..... Type: .....  
 Address: ..... Serial no.: .....  
 ..... Repair order no.: .....

Scope of inspection	o.k.	yes	no	repaired
Type plate (on hand)				
Operating manual (on hand)				
Protective covering, Protective device				
Pressure line (tightness)				
Stainless steel pressure gauge (function)				
Float valve (tightness)				
Spraying device (marking)				
High-pressure hose / connector (damage, marking)				
Safety valve opens at 10 % / 20 % exceeding				
power supply cable (damage)				
Protective conductor (connected)				
On / Off switch				

Inspection data	determined value	set value
High-pressure nozzle		
Operating pressure .....bar		
Switch off pressure .....bar		
protective conductor resistance not exceeded / value		
Insulation		
Leakage current		
Safety trigger gun locked		

**Inspection result (check)**

- The high-pressure cleaner was checked by an expert according to the Guidelines for Liquid Spray Equipment, the defects found have been rectified so that the Labour Safety can be confirmed.
- The high-pressure cleaner was checked by an expert according to the Guidelines for Liquid Spray Equipment. The Labour Safety cannot be confirmed unless the defects found are rectified by repair or replacement of the faulty parts.

The next retest according to the Guidelines for Liquid Spray Equipment has to be carried out by: Month ..... Year .....  
 Place, Date ..... Signature .....

**High-pressure cleaners for industrial use have to be checked by an expert every 12 months!** Inspection report on annually carried out Labour Safety Inspection (UVV) according to the Guidelines for Liquid Spray Equipment. (This inspection sheet serves as proof for the completion of the retest and must be kept carefully!)

Kränzle-test seals: Item no.: UVV200106

Owner: ..... Type: .....  
 Address: ..... Serial no.: .....  
 ..... Repair order no.: .....

Scope of inspection	o.k.	yes	no	repaired
Type plate (on hand)				
Operating manual (on hand)				
Protective covering, Protective device				
Pressure line (tightness)				
Stainless steel pressure gauge (function)				
Float valve (tightness)				
Spraying device (marking)				
High-pressure hose / connector (damage, marking)				
Safety valve opens at 10 % / 20 % exceeding				
power supply cable (damage)				
Protective conductor (connected)				
On / Off switch				

Inspection data	determined value	set value
High-pressure nozzle		
Operating pressure .....bar		
Switch off pressure .....bar		
protective conductor resistance not exceeded / value		
Insulation		
Leakage current		
Safety trigger gun locked		

**Inspection result (check)**

- The high-pressure cleaner was checked by an expert according to the Guidelines for Liquid Spray Equipment, the defects found have been rectified so that the Labour Safety can be confirmed.
- The high-pressure cleaner was checked by an expert according to the Guidelines for Liquid Spray Equipment. The Labour Safety cannot be confirmed unless the defects found are rectified by repair or replacement of the faulty parts.

The next retest according to the Guidelines for Liquid Spray Equipment has to be carried out by: Month ..... Year .....  
 Place, Date ..... Signature .....

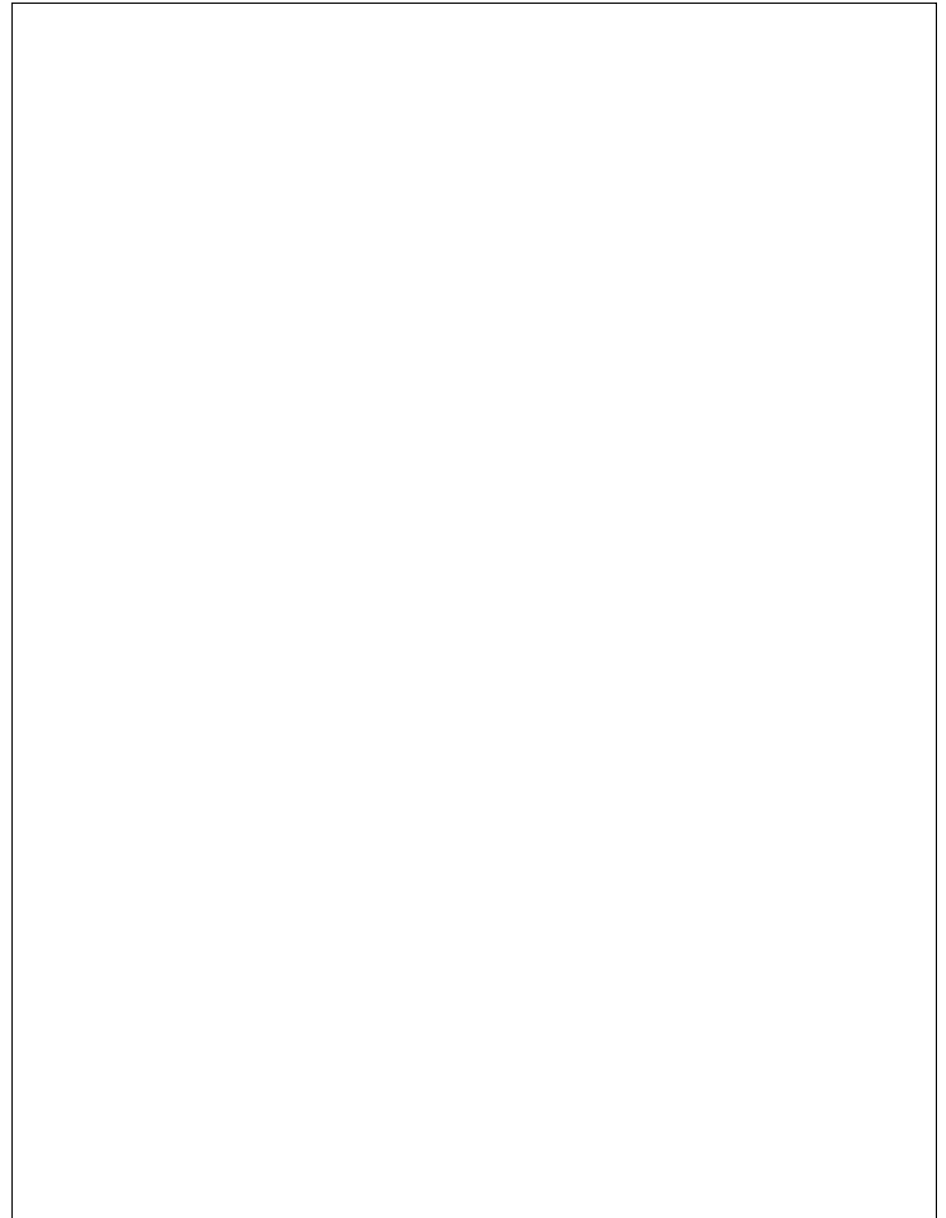
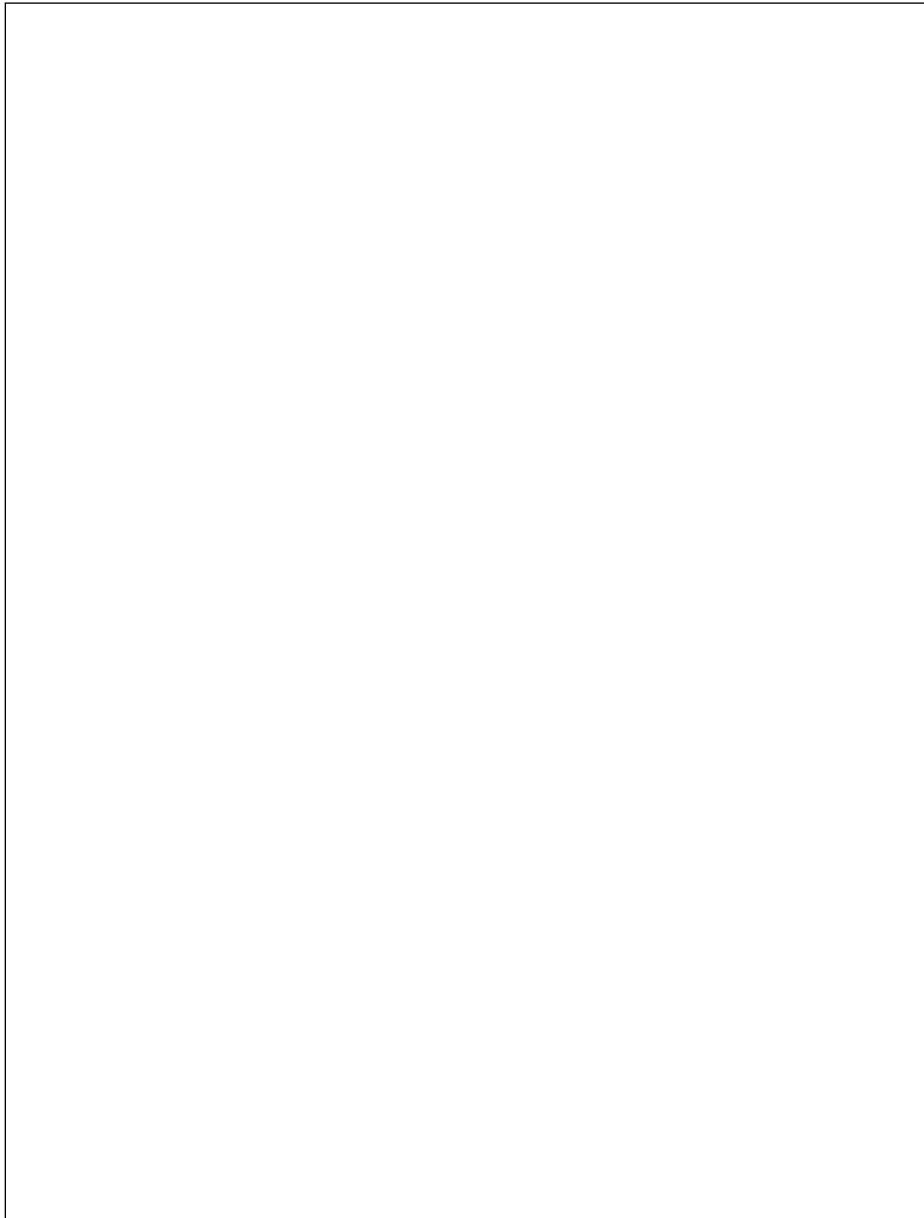



**Josef Kränzle GmbH & Co. KG**

Rudolf-Diesel-Straße 20  
89257 Illertissen (Germany)

[sales@kraenzle.com](mailto:sales@kraenzle.com)

© Kranzle 02.03.2021 / Ord. no.: 306063 / Subject to technical modifications and errors.

■ **Made**  
■ **in**  
■ **Germany**